

A

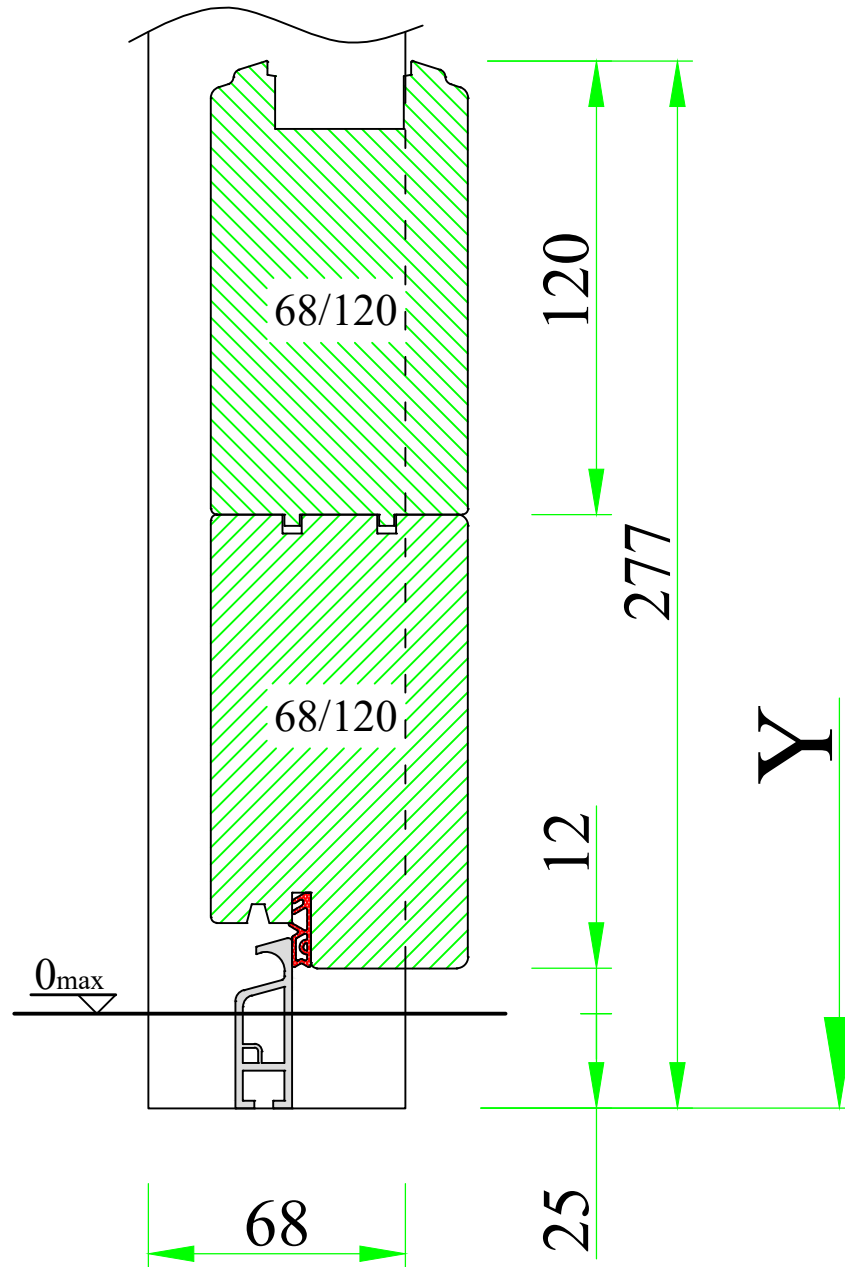

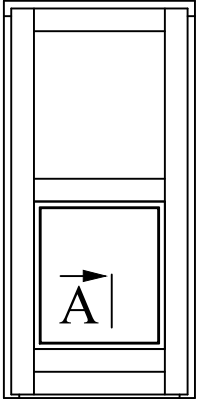

A

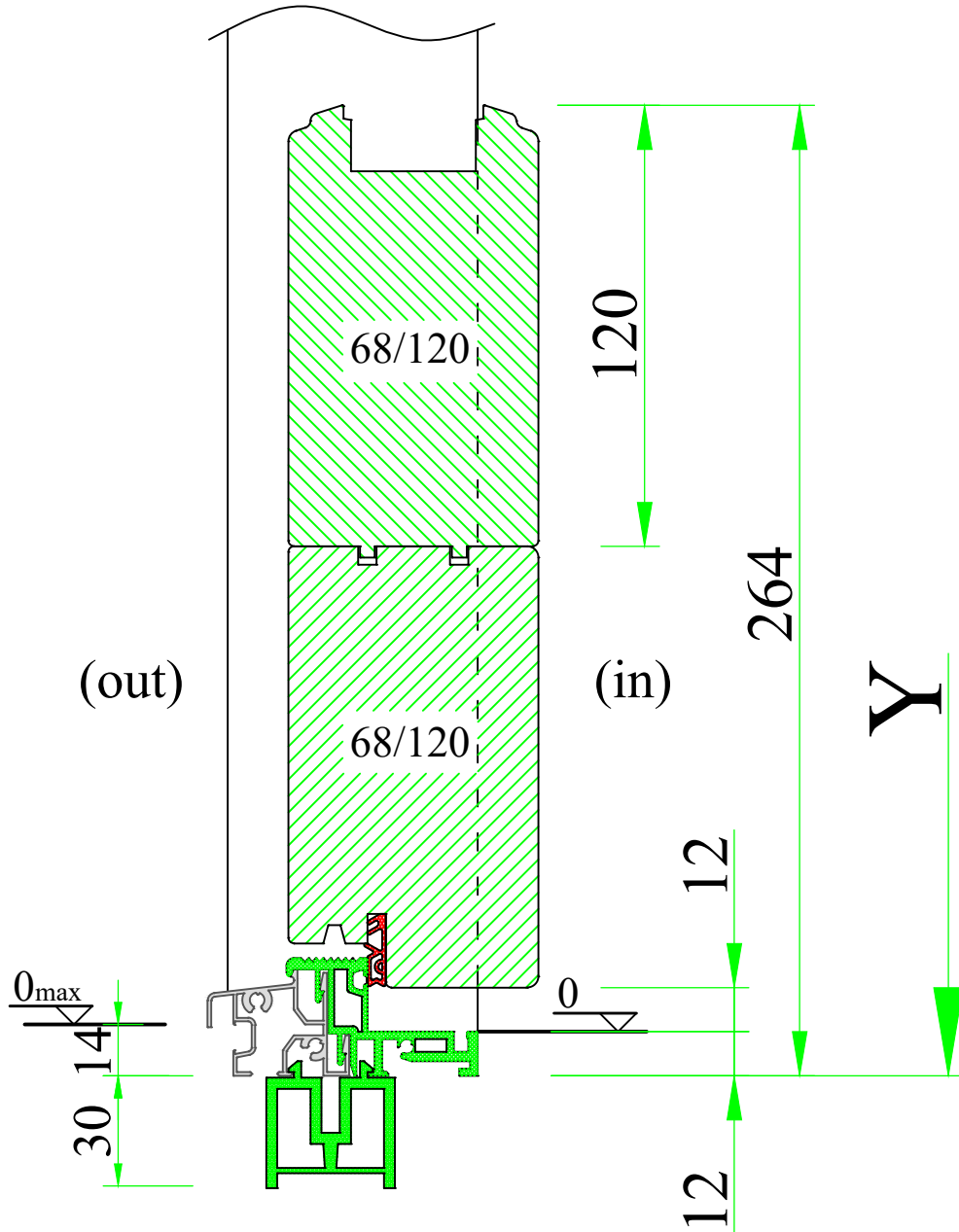

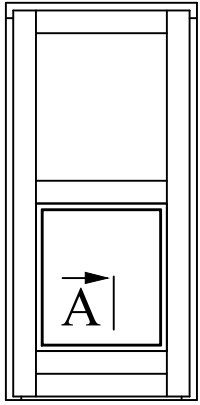

A

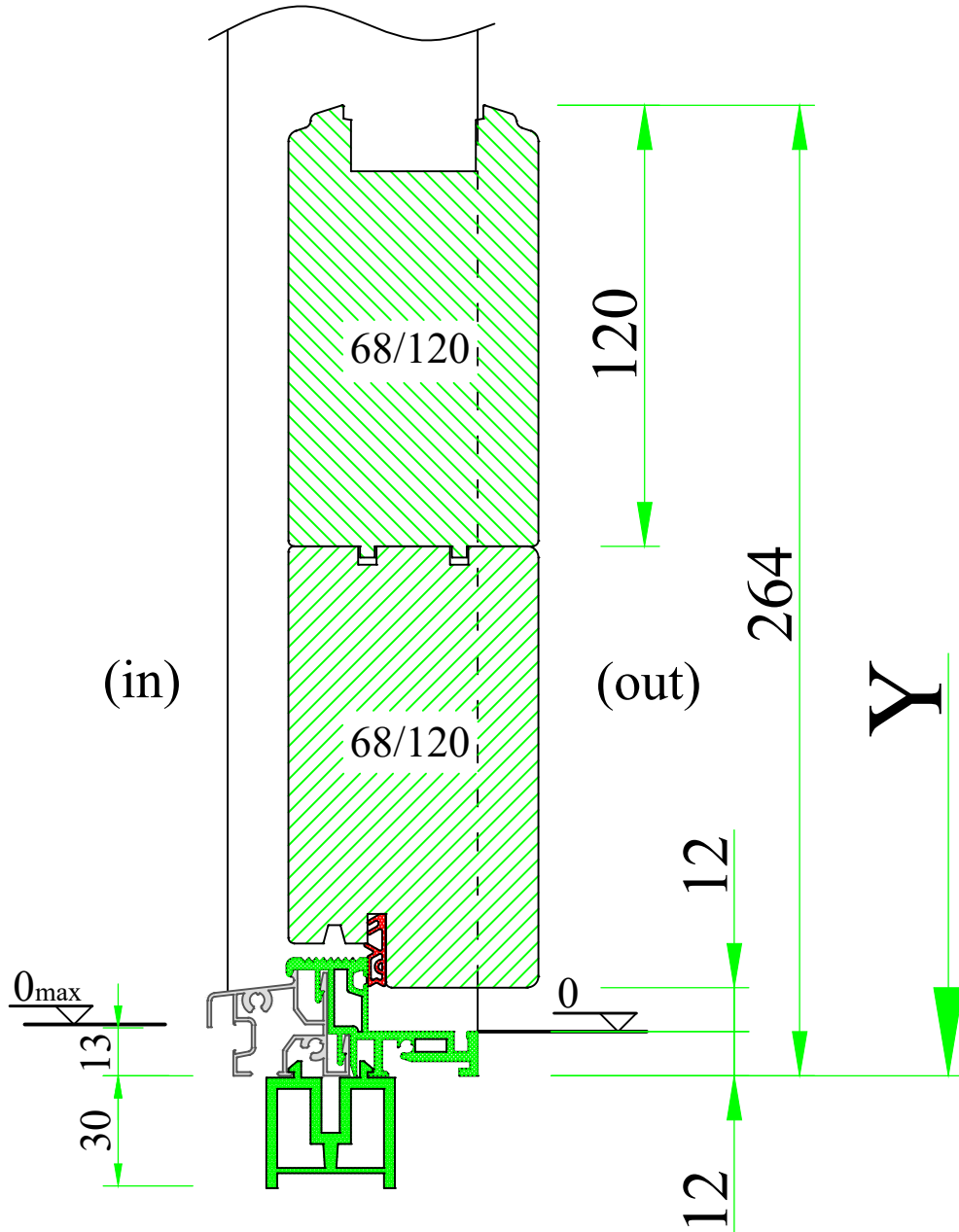

**UNI WINDOWS Ltd.**  
 Unit 6, Edgefield Industrial Est.  
 Loanhead, EH20 9TB  
 Tel.: 0131 448 3931

**ENTRANCE DOOR 68**  
 External door with aluminium threshold  
 Weser (new) – outward opening

Version:  
1  
 Date:  
15.05.14

Scale:  
1:2  
 Drawing:  
NZ/2-1

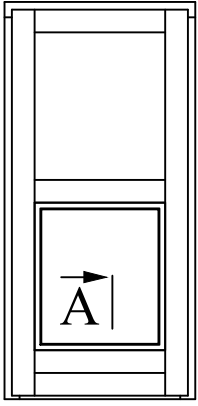

A

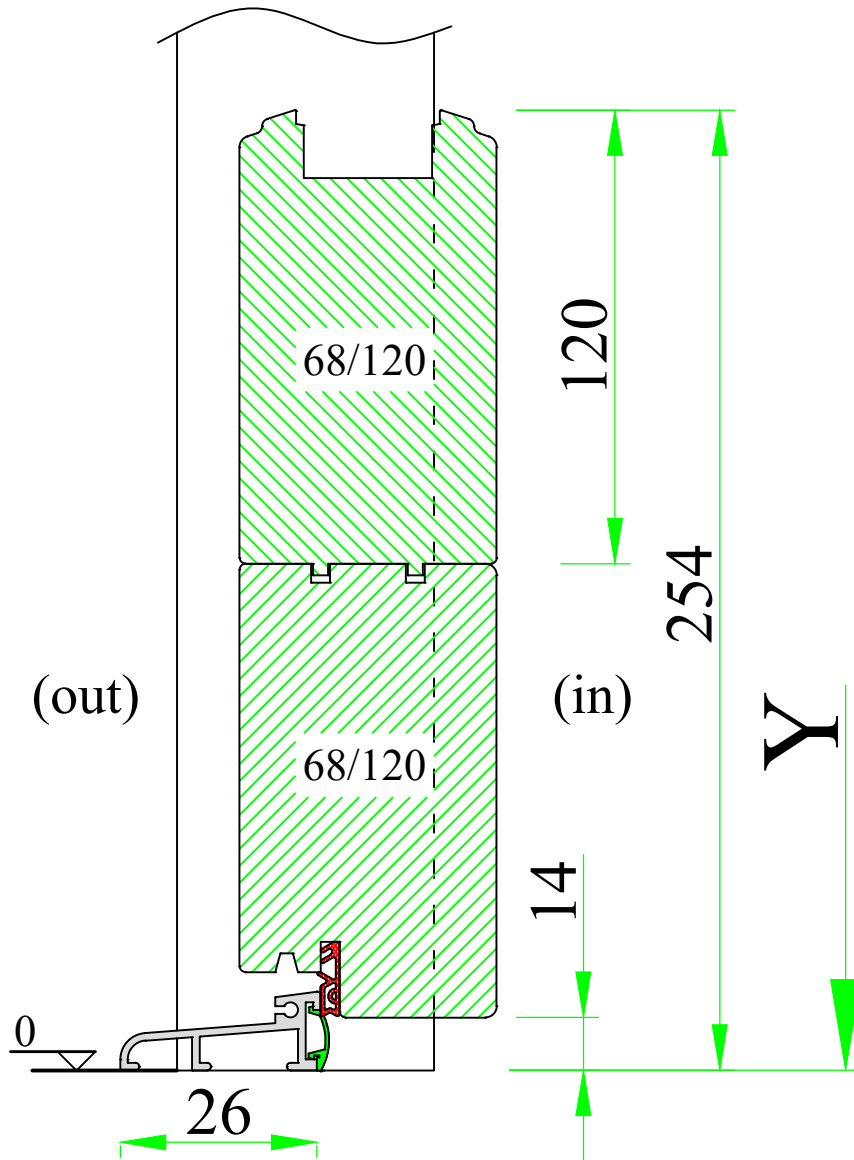

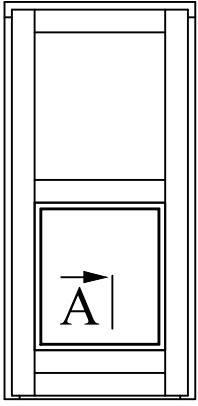

A

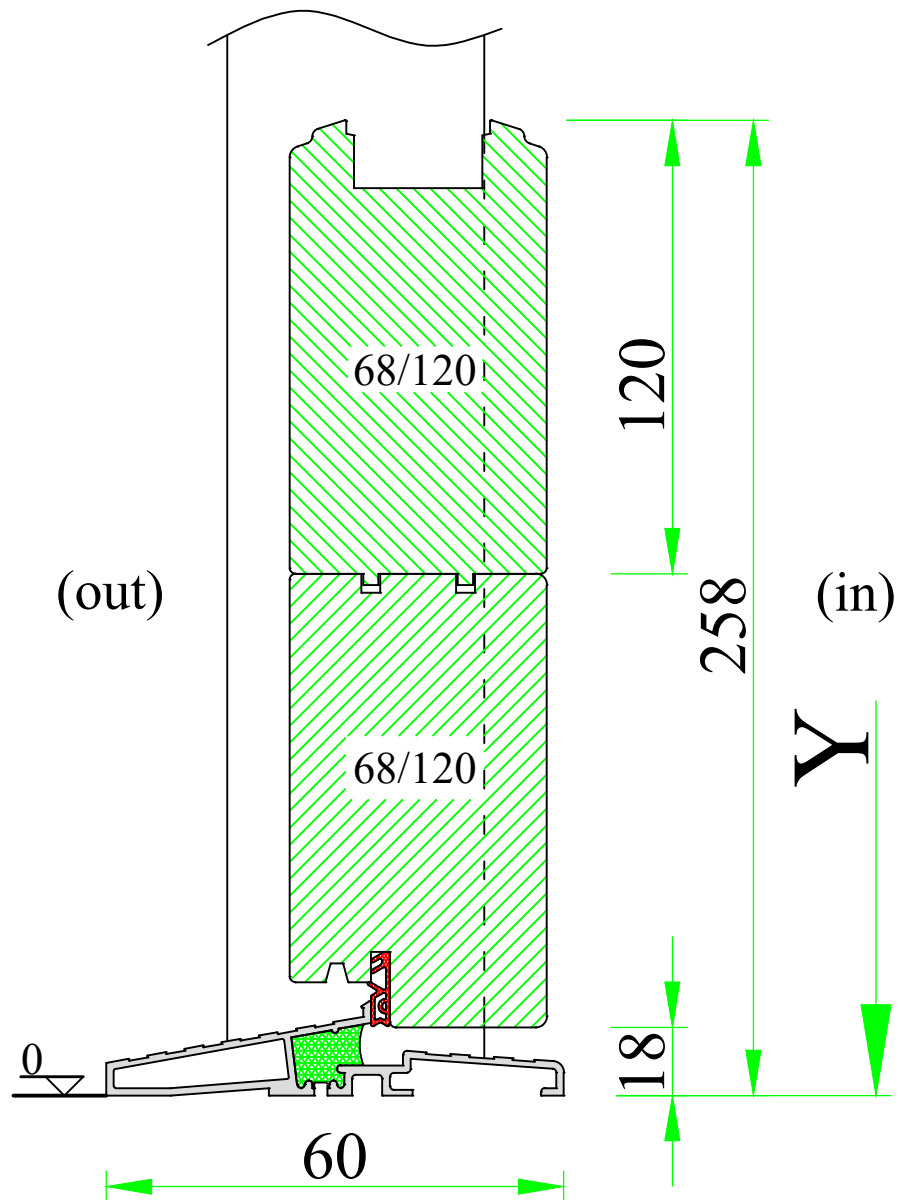

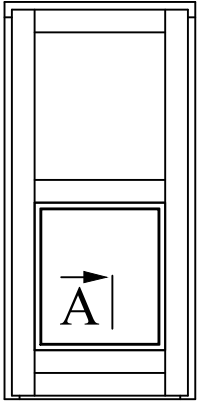

A

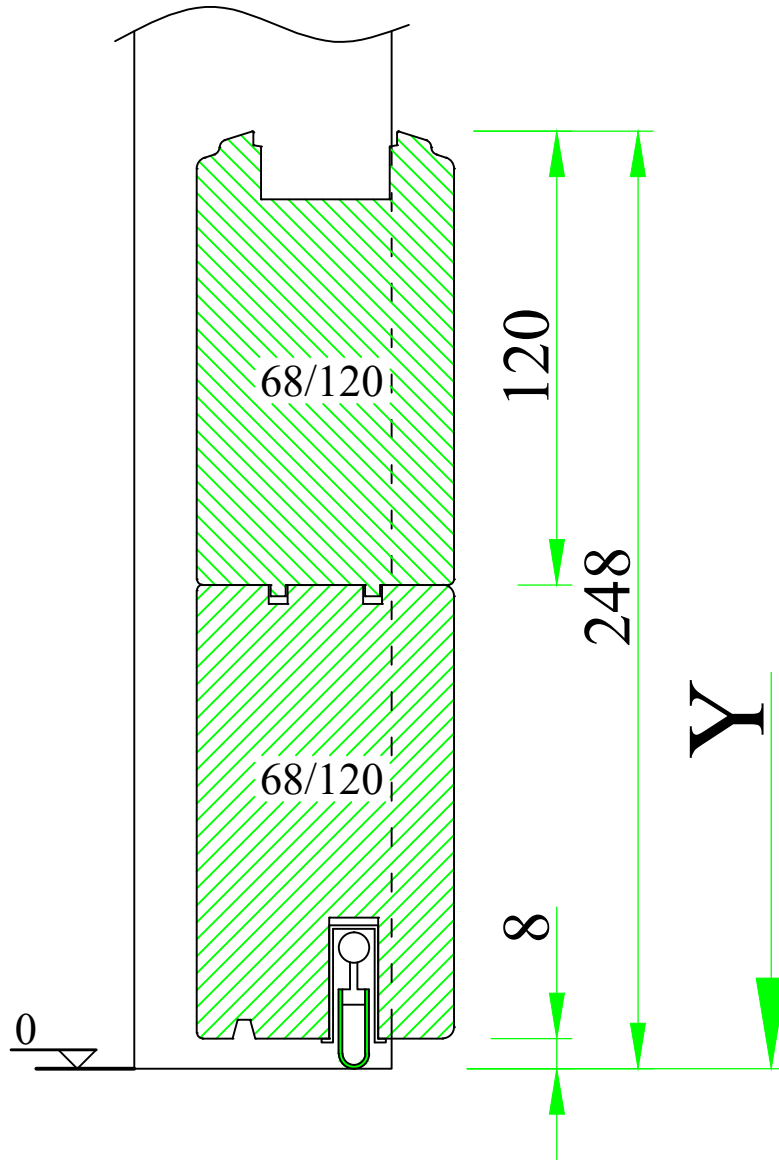

**UNI WINDOWS Ltd.**  
 Unit 6, Edgefield Industrial Est.  
 Loanhead, EH20 9TB  
 Tel.: 0131 448 3931

**ENTRANCE DOOR 68**  
 External door – threshold free, movable gasket.

Version:  
1  
 Date:  
15.05.14

Scale:  
1:2  
 Drawing:  
NZ/5

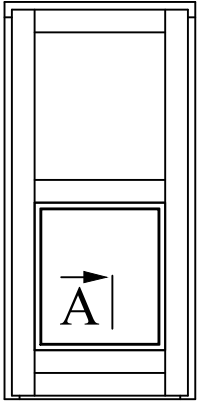

A

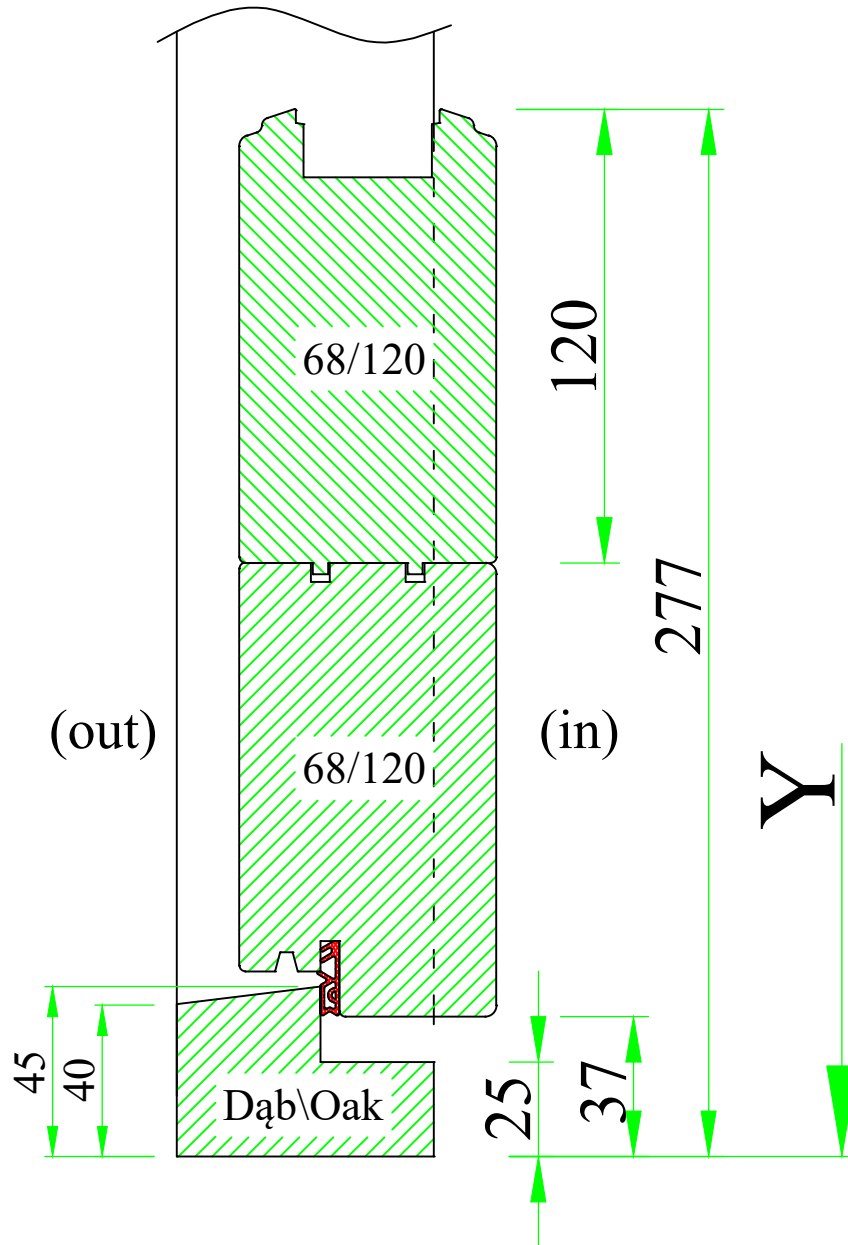

**UNI WINDOWS Ltd.**  
 Unit 6, Edgefield Industrial Est.  
 Loanhead, EH20 9TB  
 Tel.: 0131 448 3931

**ENTRANCE DOOR 68**  
 External door with timber threshold

Version:  
1  
Date:  
15.05.14

Scale:  
1:2  
Drawing:  
NZ/6

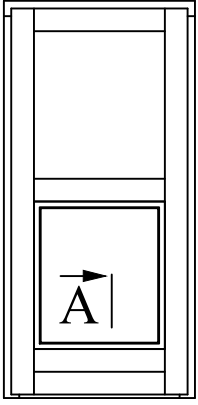

A

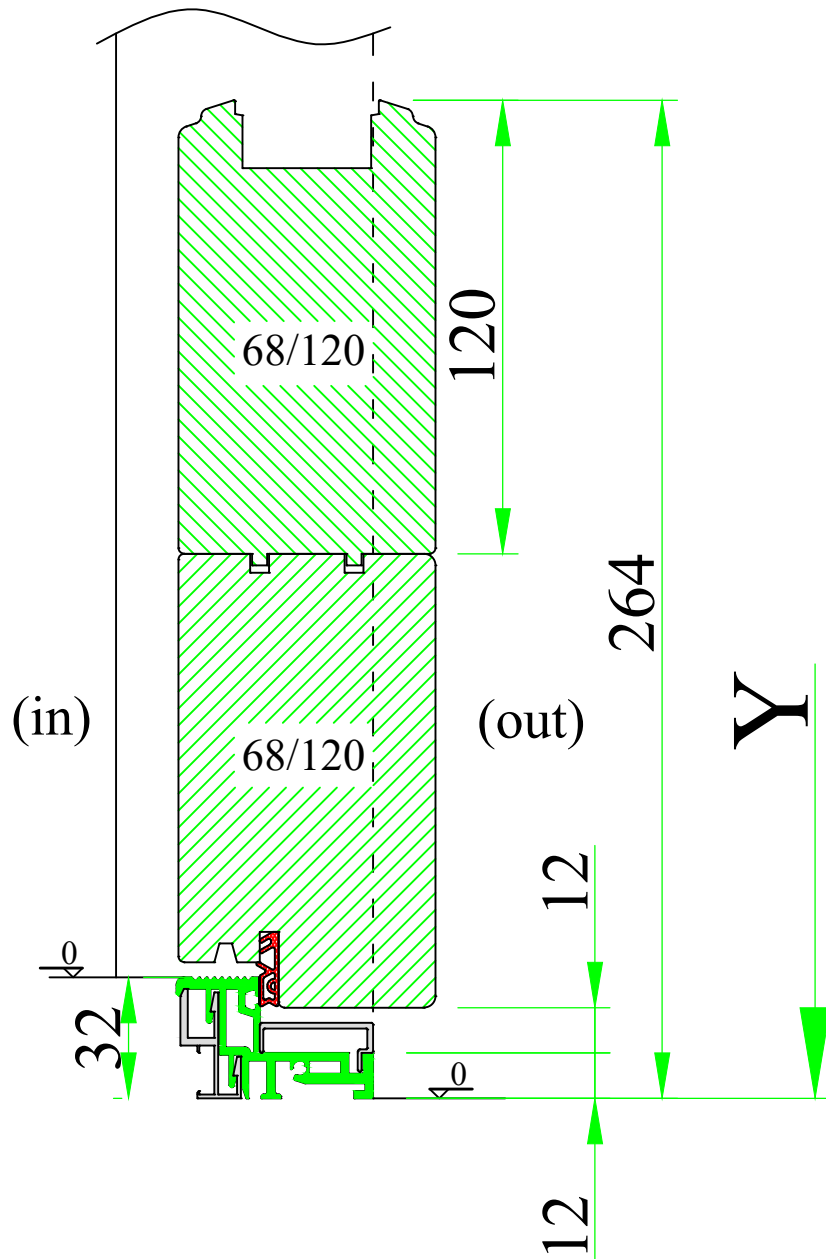

**UNI WINDOWS Ltd.**  
 Unit 6, Edgefield Industrial Est.  
 Loanhead, EH20 9TB  
 Tel.: 0131 448 3931

**ENTRANCE DOOR 68**  
 External door with Weser-A threshold -  
 - outward opening

Version:  
1  
 Date:  
15.05.14

Scale:  
1:2  
 Drawing:  
NZ/7



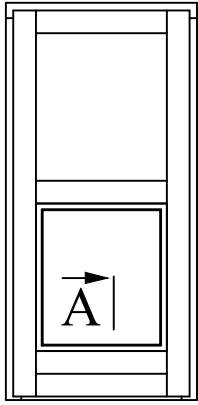

A

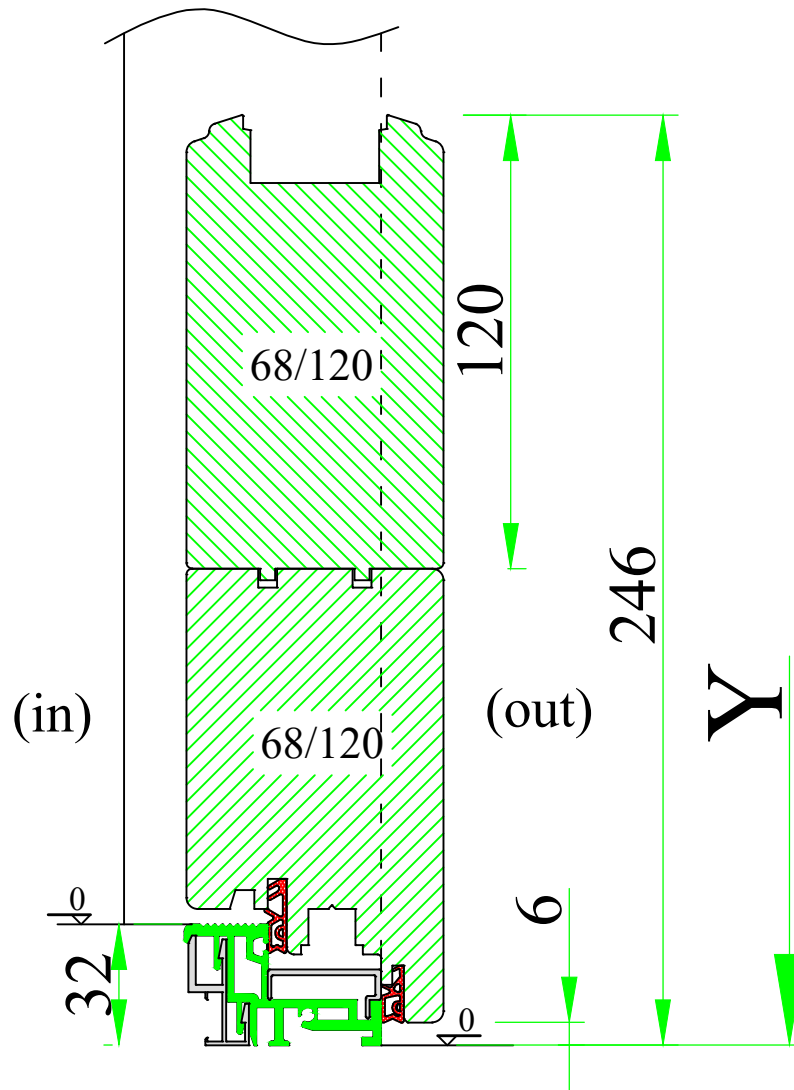

(in)

68/120

120

68/120

(out)

246

Y

32

6

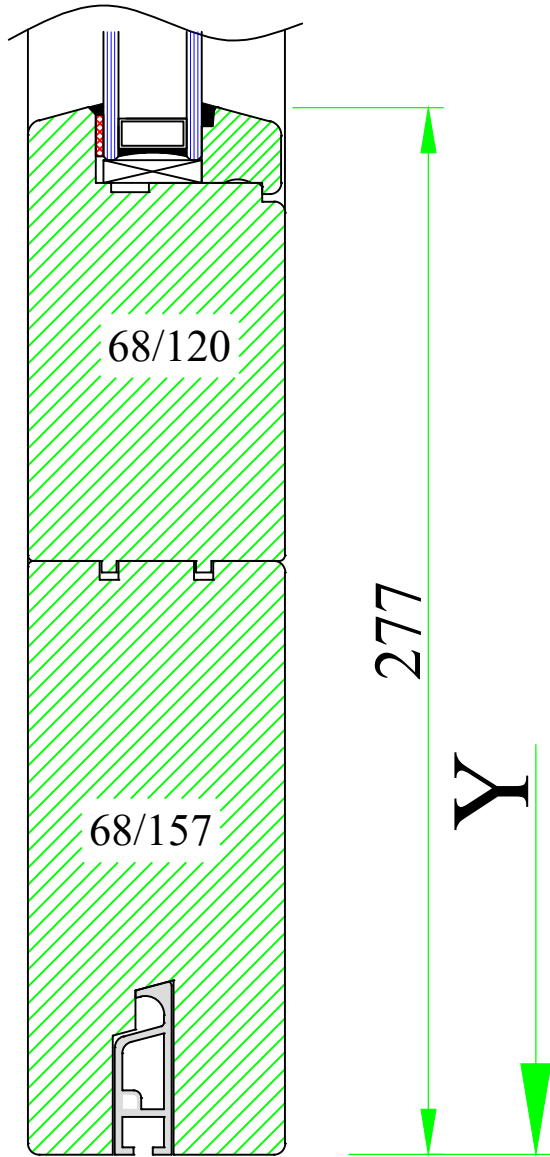
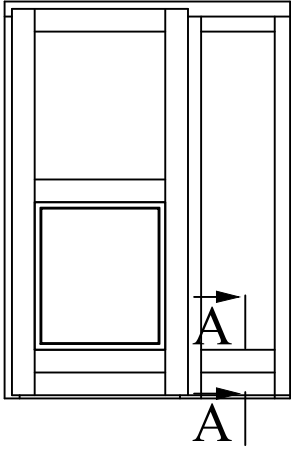

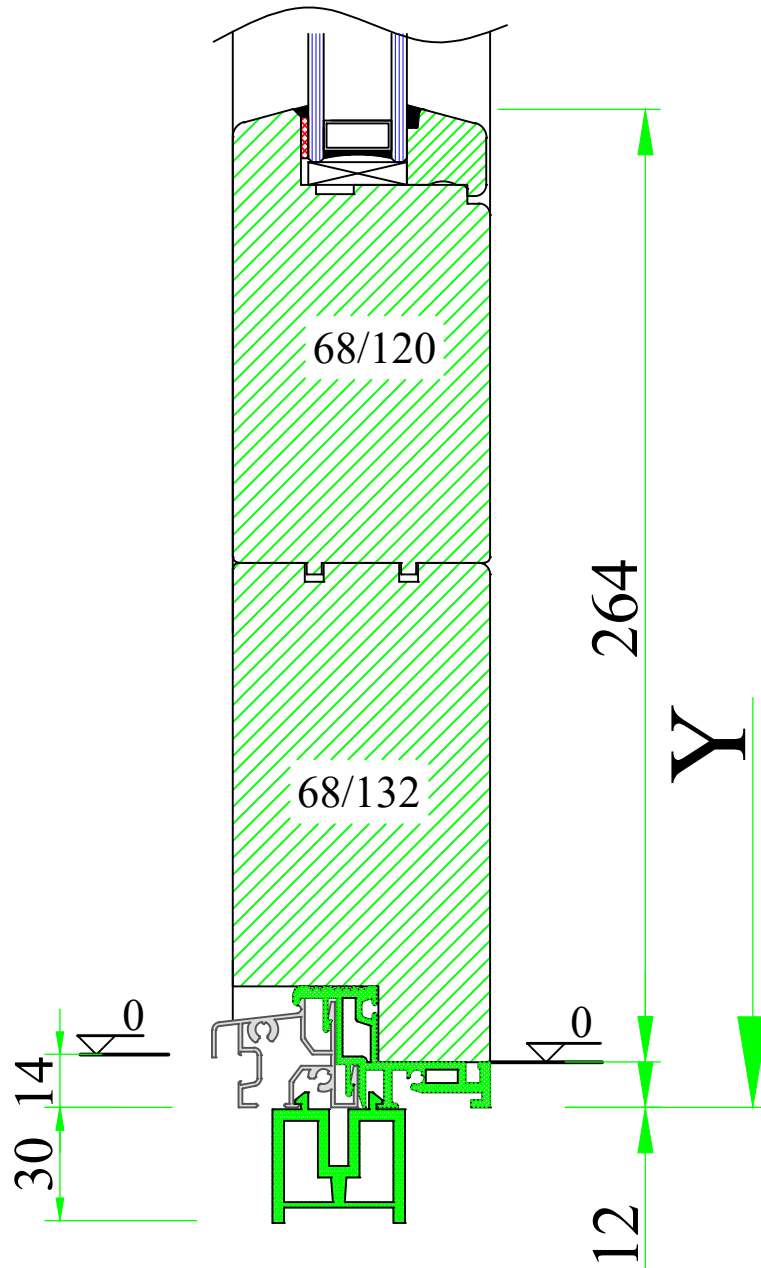
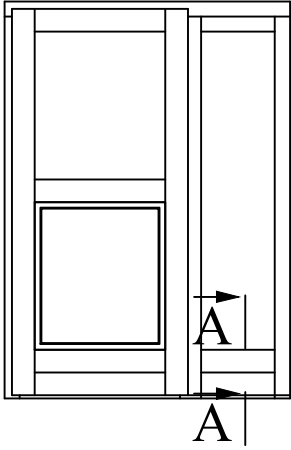

**UNI WINDOWS Ltd.**  
 Unit 6, Edgefield Industrial Est.  
 Loanhead, EH20 9TB  
 Tel.: 0131 448 3931

**ENTRANCE DOOR 68**  
 Frame extension for glass equalization –  
 with Weser aluminium threshold (new)

Version: 1	Scale: 1:2
Date: 15.05.14	Drawing: NZ/10

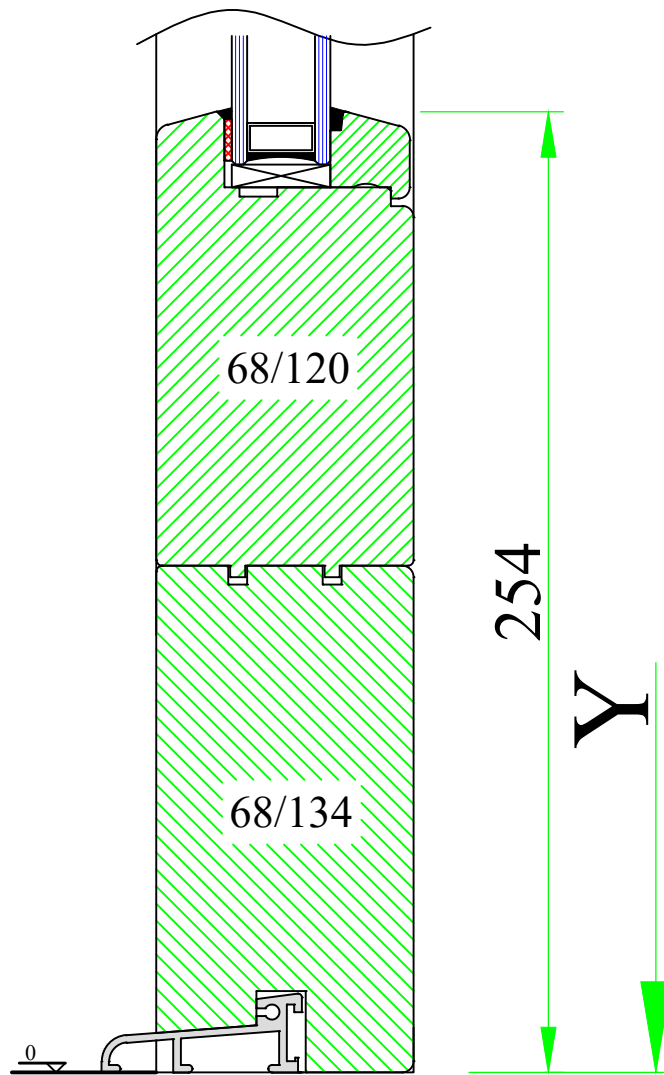
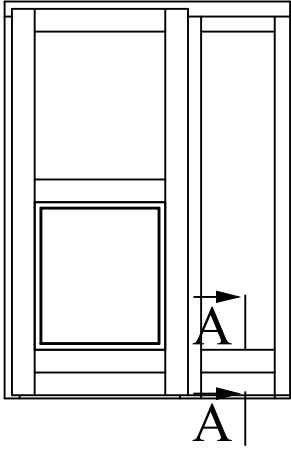

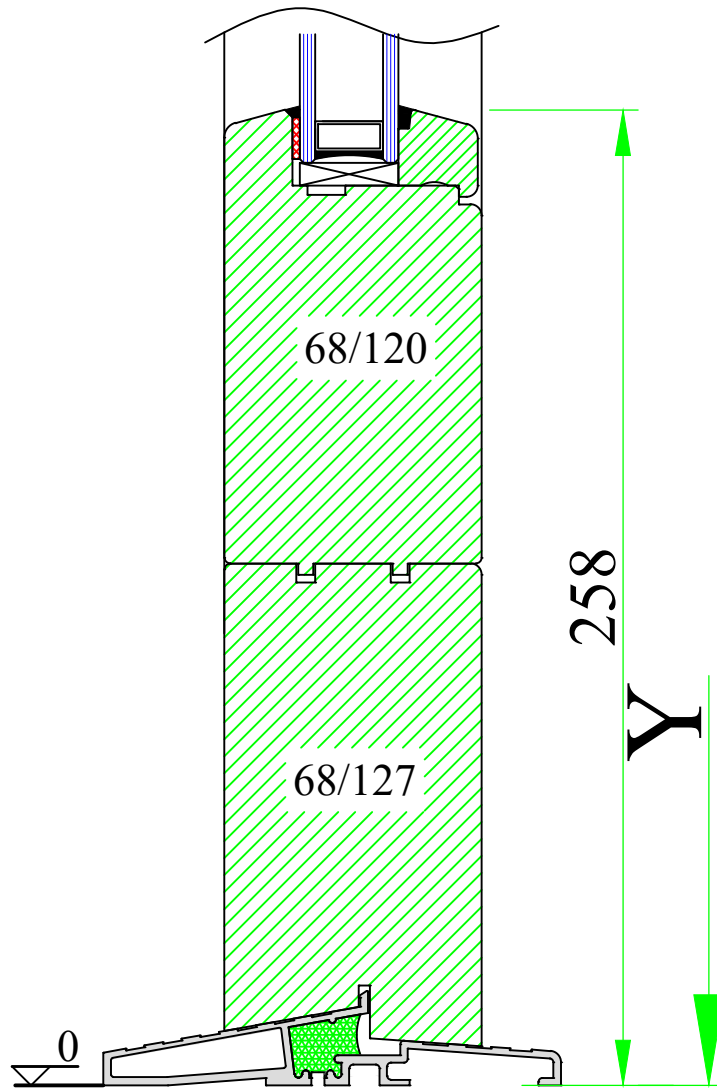
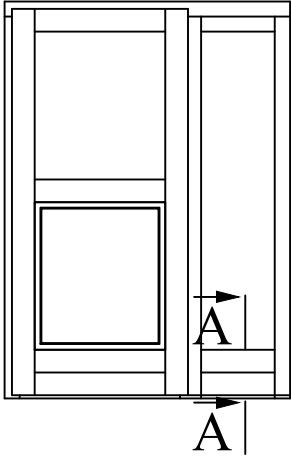

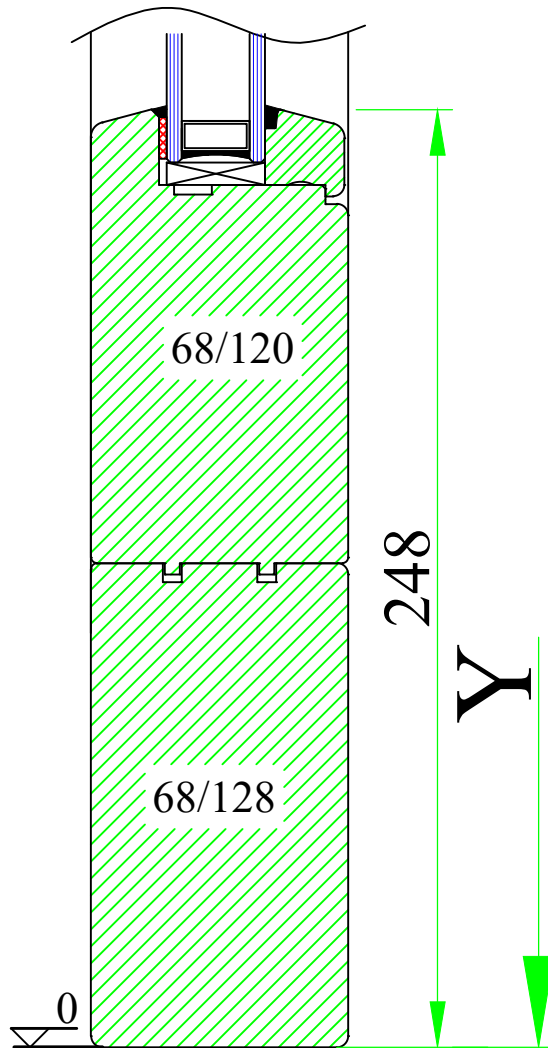
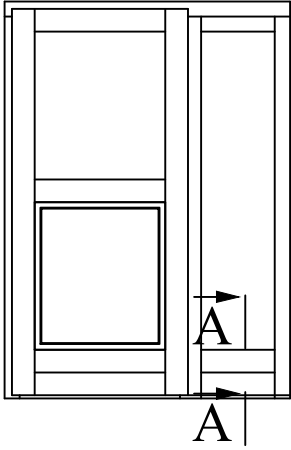

→  
A

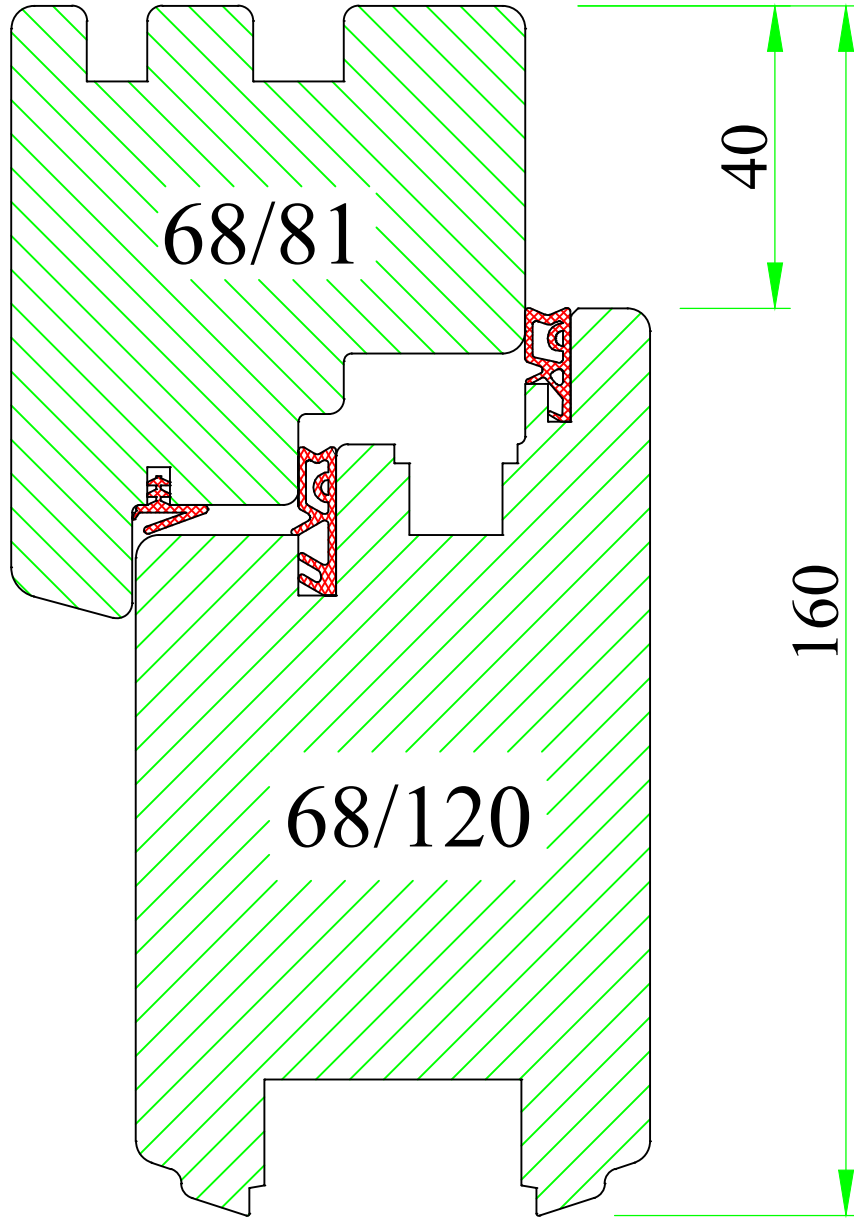
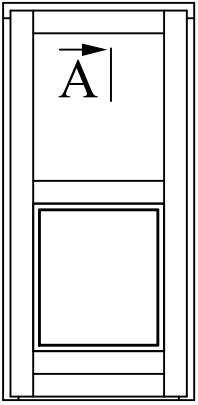

**UNI WINDOWS Ltd.**  
Unit 6, Edgefield Industrial Est.  
Loanhead, EH20 9TB  
Tel.: 0131 448 3931

**ENTRANCE DOOR 68**  
Frame-sash connection – top and sides

Version:  
1  
Date:  
15.05.14

Scale:  
1:1  
Drawing:  
NZ/20

# STANDARD

NZ/21

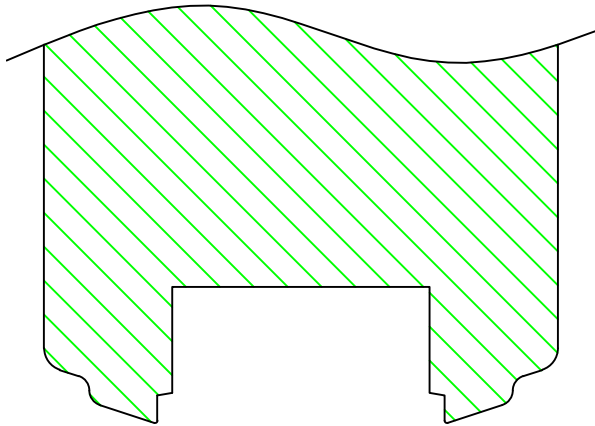

NZ/21/1

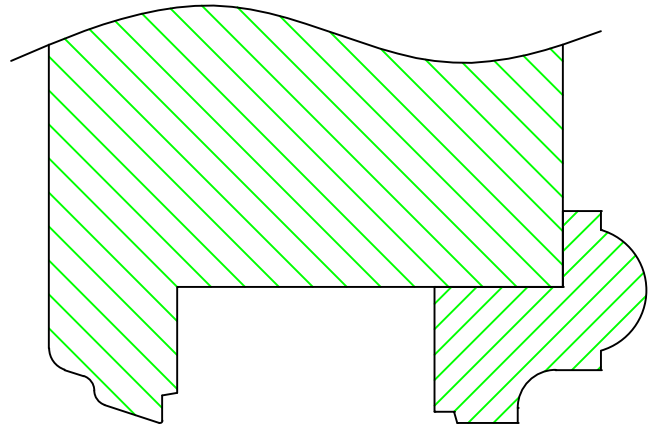

# OPTIONS

NZ/21/2

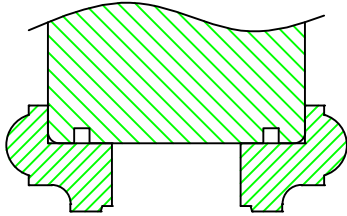

NZ/21/3

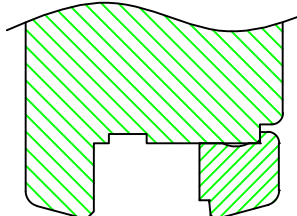

NewLine

NZ/21/4

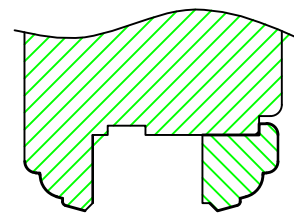

Retro

NZ/21/5

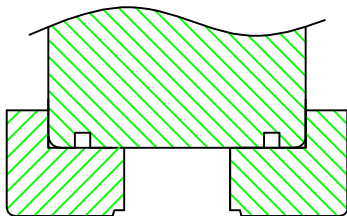

Deco, Modern



**UNI WINDOWS Ltd.**  
Unit 6, Edgefield Industrial Est.  
Loanhead, EH20 9TB  
Tel.: 0131 448 3931

ENTRANCE DOOR 68

Version:  
1

Scale:  
1:2

Date:  
15.05.14

Drawing:  
NZ/21



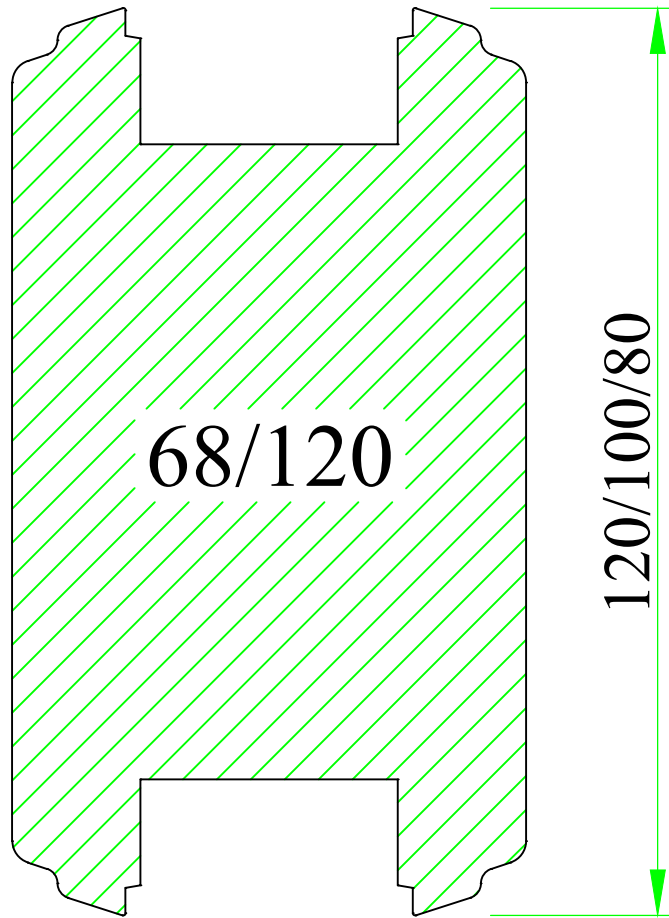
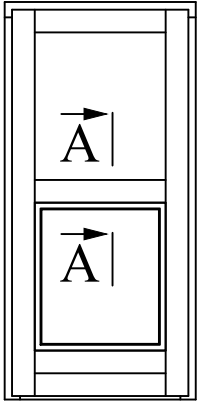

68/120

120/100/80

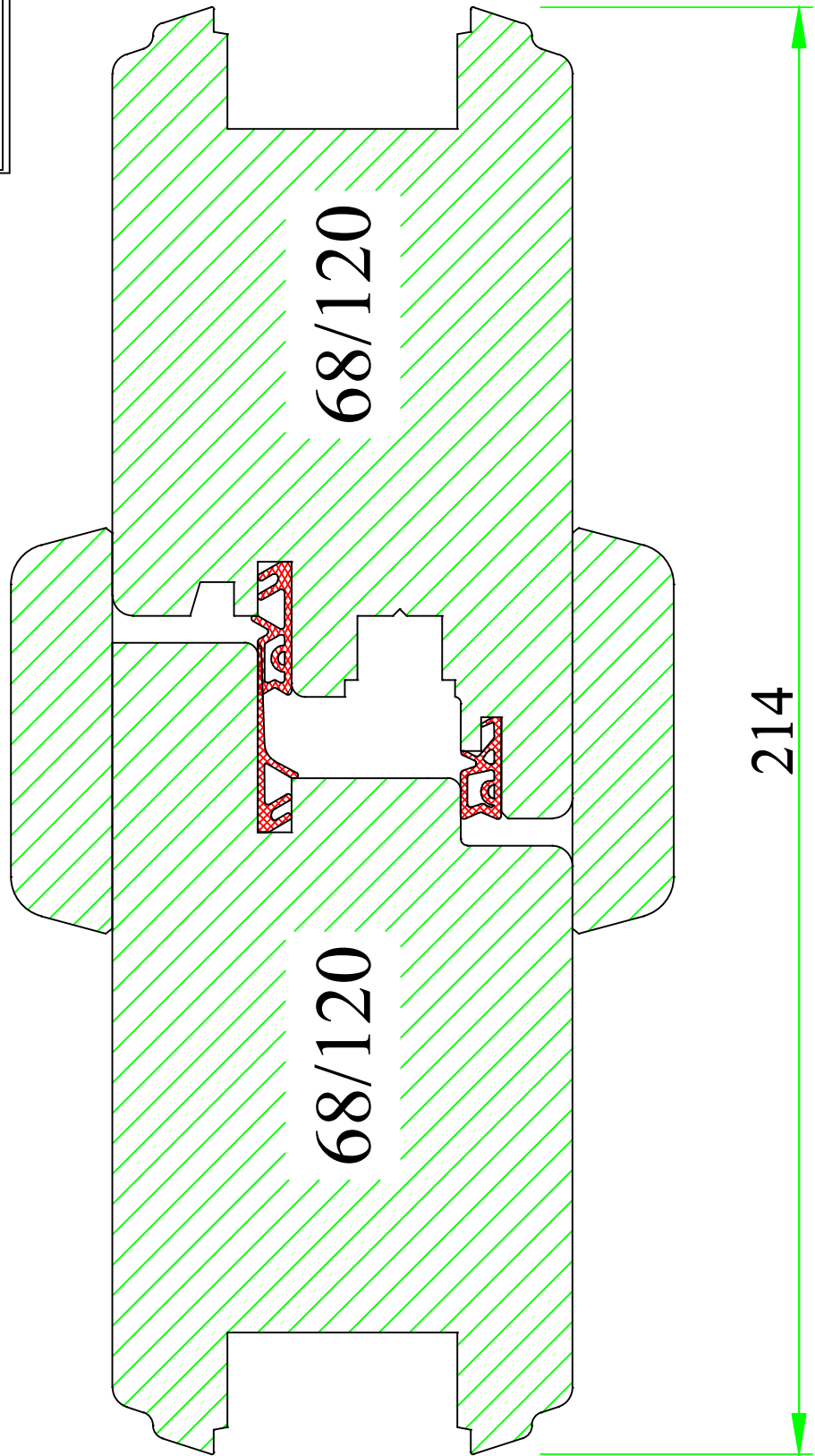
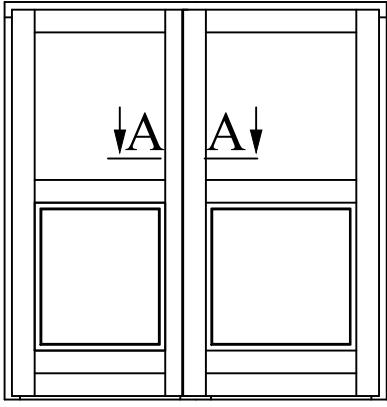

**UNI WINDOWS Ltd.**  
 Unit 6, Edgefield Industrial Est.  
 Loanhead, EH20 9TB  
 Tel.: 0131 448 3931

'Flying' mullion

ENTRANCE DOOR 68

Version:  
1

Scale:  
1:1

Date:  
15.05.14

Drawing:  
NZ/24

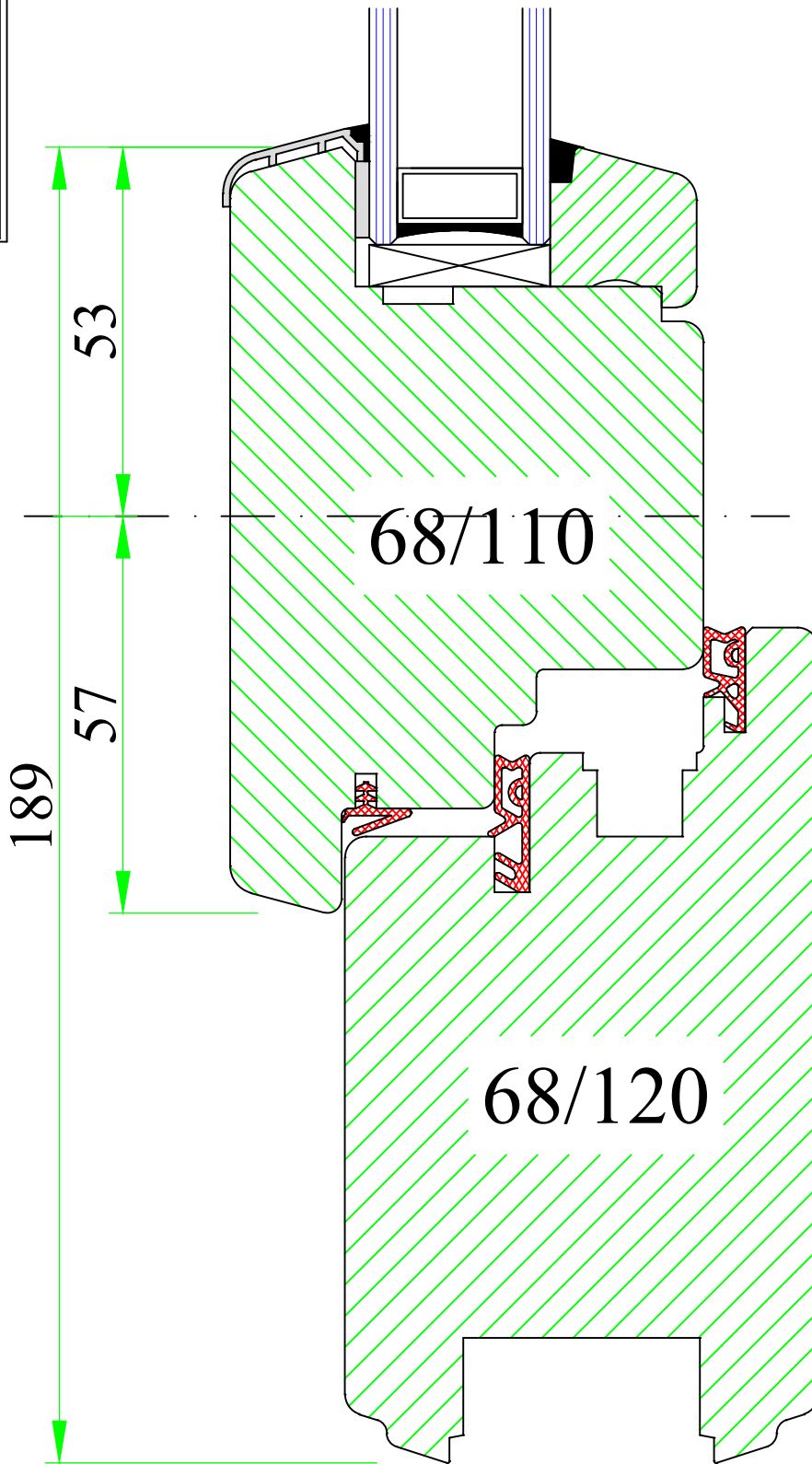
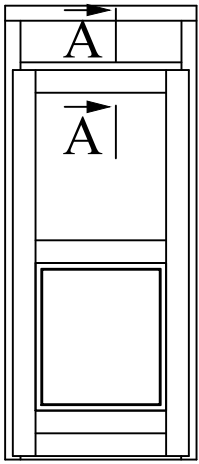

**UNI WINDOWS Ltd.**  
 Unit 6, Edgefield Industrial Est.  
 Loanhead, EH20 9TB  
 Tel.: 0131 448 3931

**ENTRANCE DOOR 68**  
 Door with fixed top light

Version: 1	Scale: 1:2
Date: 15.05.14	Drawing: NZ/25

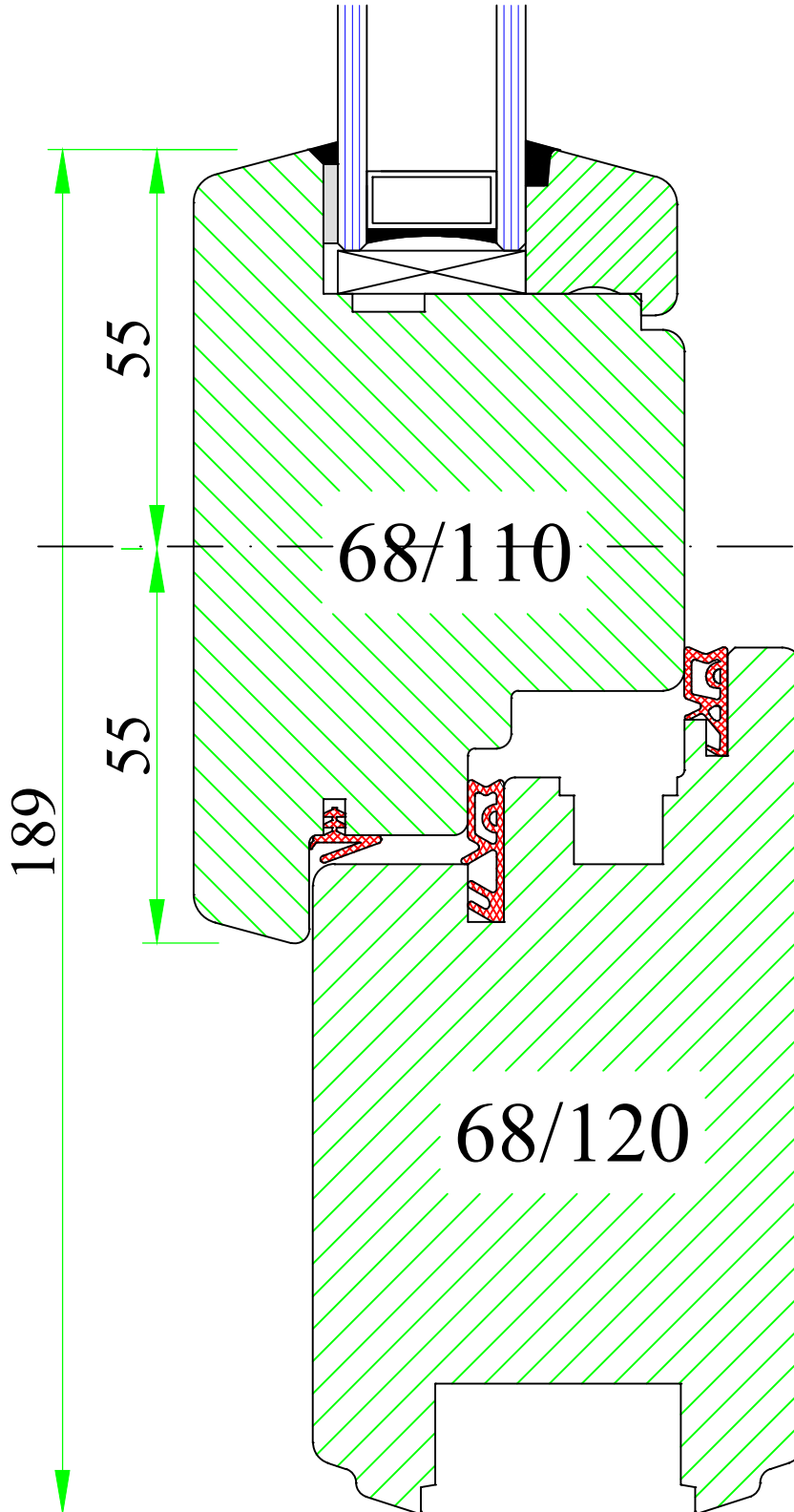
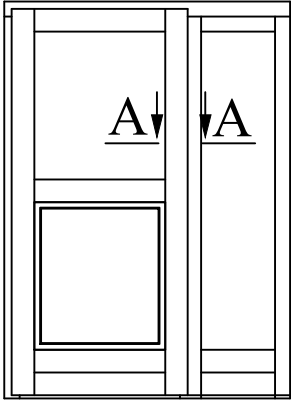

**UNI WINDOWS Ltd.**  
 Unit 6, Edgefield Industrial Est.  
 Loanhead, EH20 9TB  
 Tel.: 0131 448 3931

**ENTRANCE DOOR 68**  
 Door with fixed side light

Version: 1	Scale: 1:1
Date: 15.05.14	Drawing: NZ/26

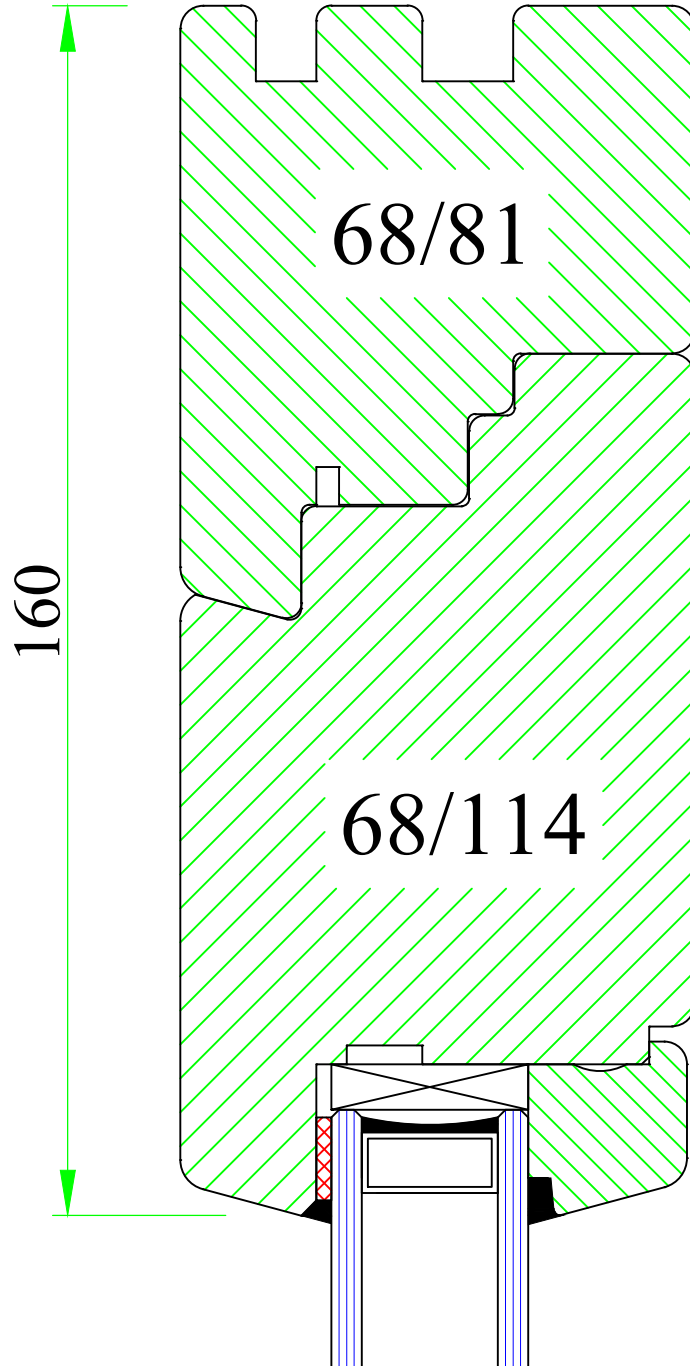
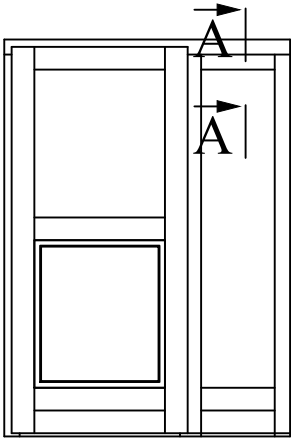

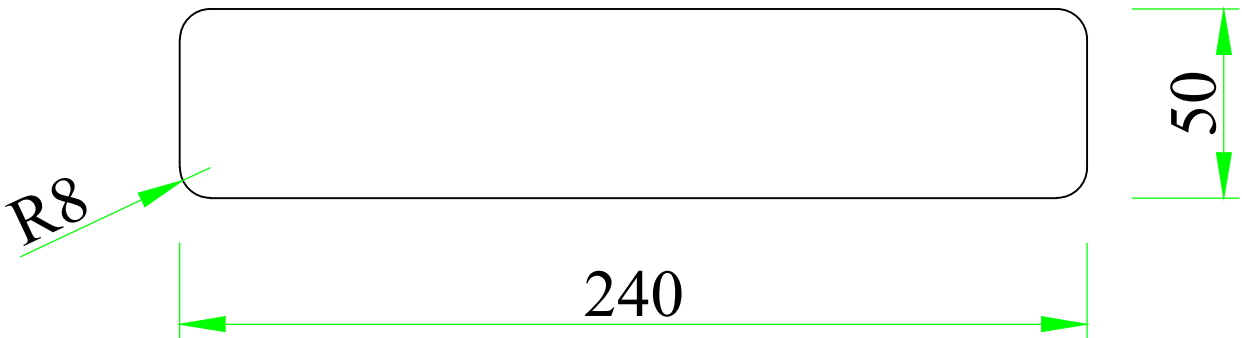
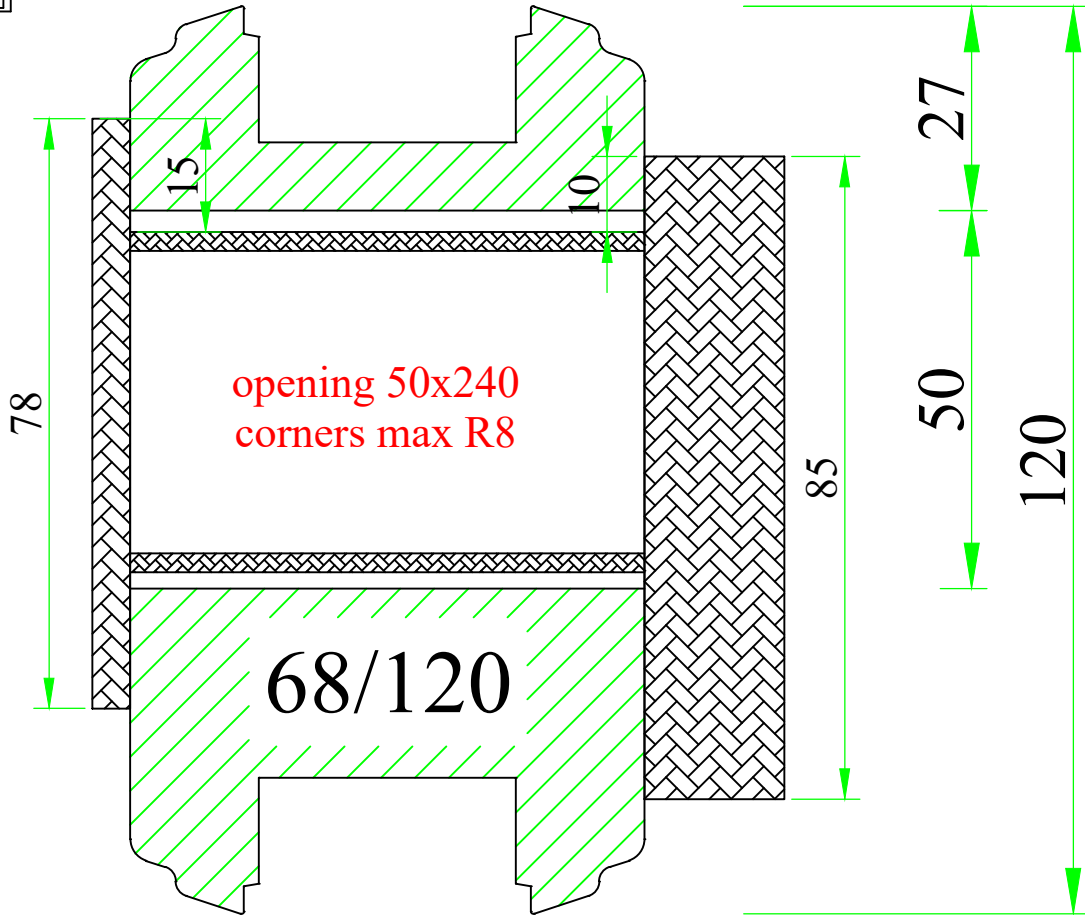
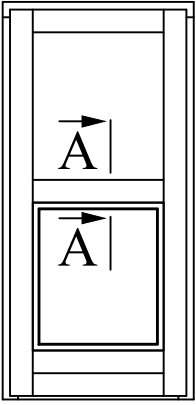

**UNI WINDOWS Ltd.**  
 Unit 6, Edgefield Industrial Est.  
 Loanhead, EH20 9TB  
 Tel.: 0131 448 3931

**ENTRANCE DOOR 68**

Version: 1	Scale: 1:2
Date: 15.05.14	Drawing: NZ/33

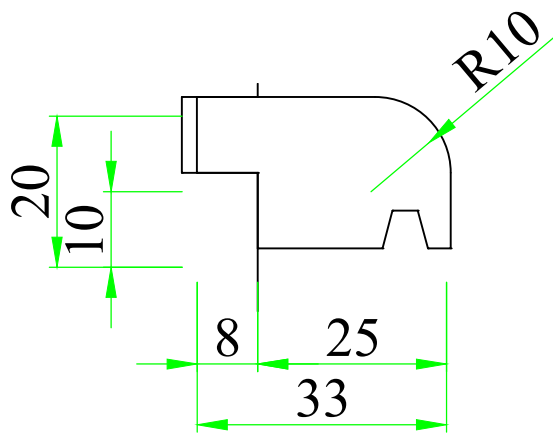
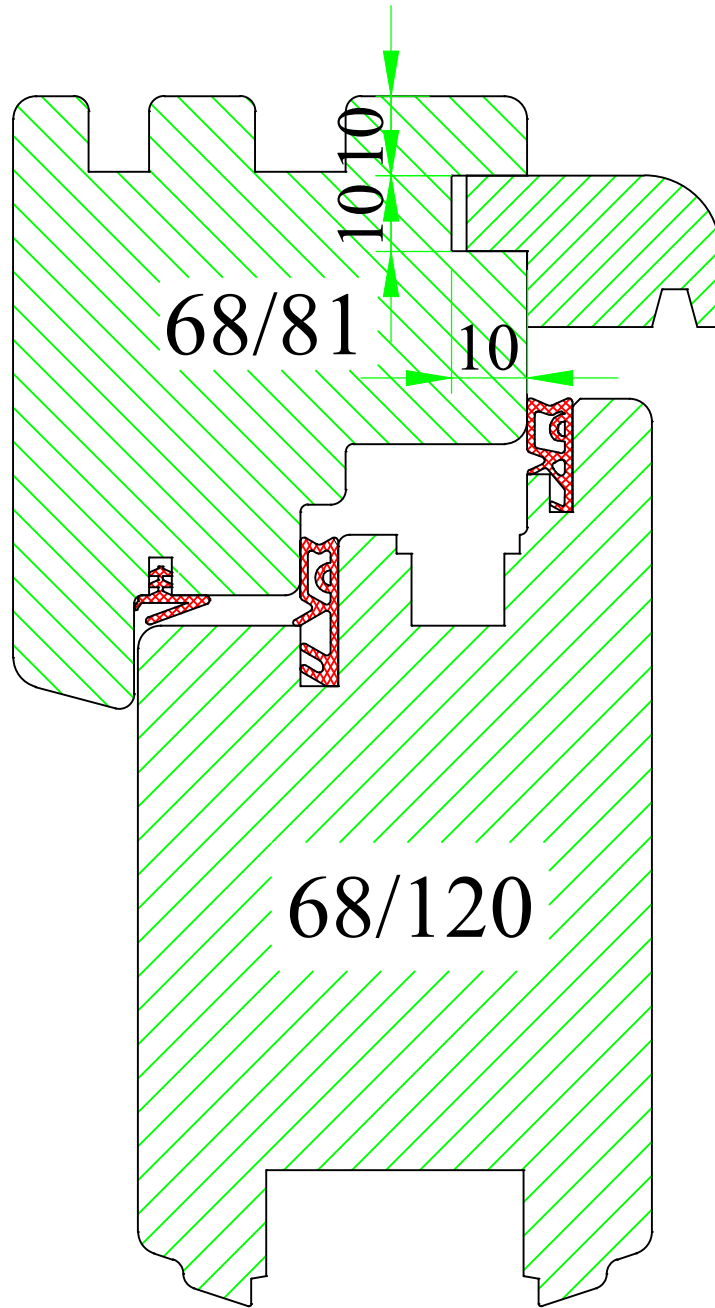
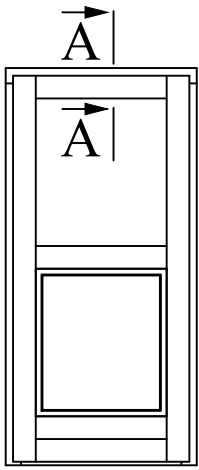

**UNI WINDOWS Ltd.**  
 Unit 6, Edgefield Industrial Est.  
 Loanhead, EH20 9TB  
 Tel.: 0131 448 3931

**ENTRANCE DOOR 68**  
 Wooden drip cap – outward opening

Version:  
1  
 Date:  
15.05.14

Scale:  
1:2  
 Drawing:  
NZ/34

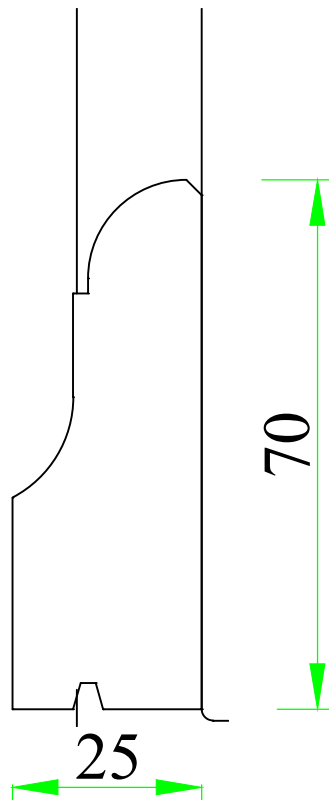
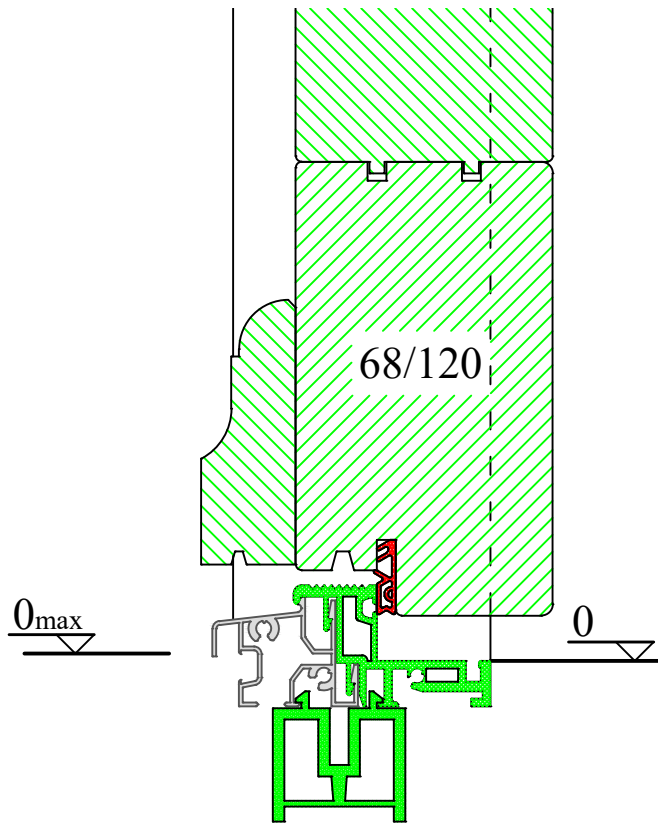
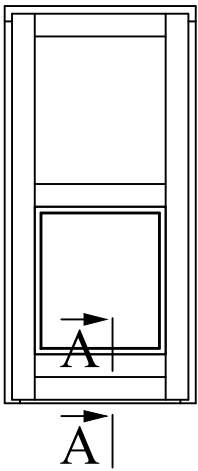



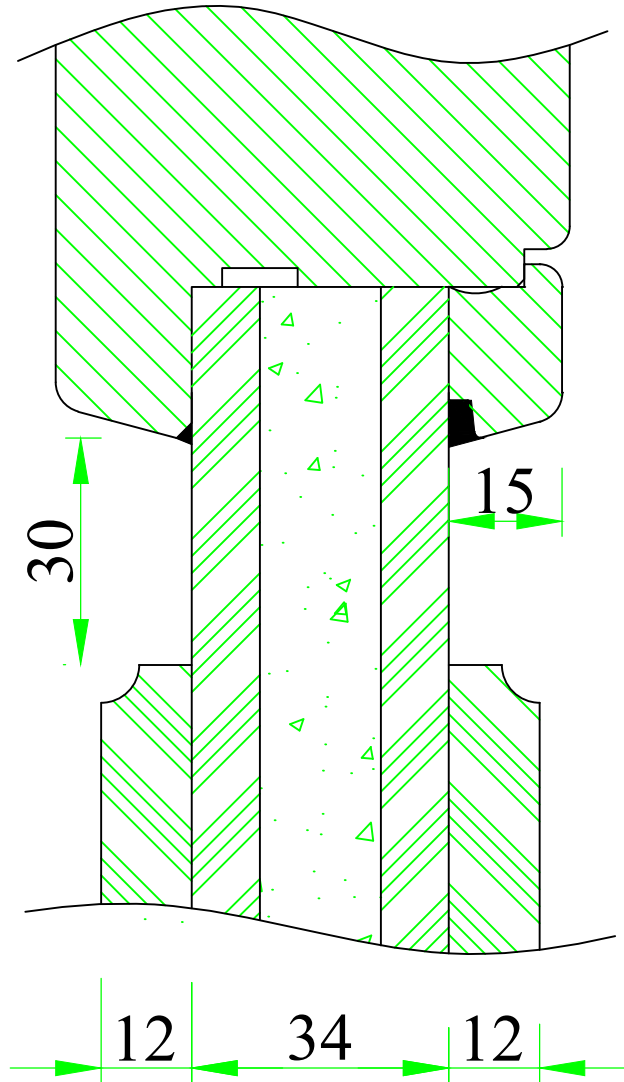
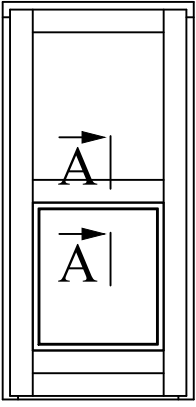

**UNI WINDOWS Ltd.**  
 Unit 6, Edgefield Industrial Est.  
 Loanhead, EH20 9TB  
 Tel.: 0131 448 3931

**ENTRANCE DOOR 68**  
 Panel board 34mm with window profile

Version: 1	Scale: 1:1
Date: 15.05.14	Drawing: NZ/36

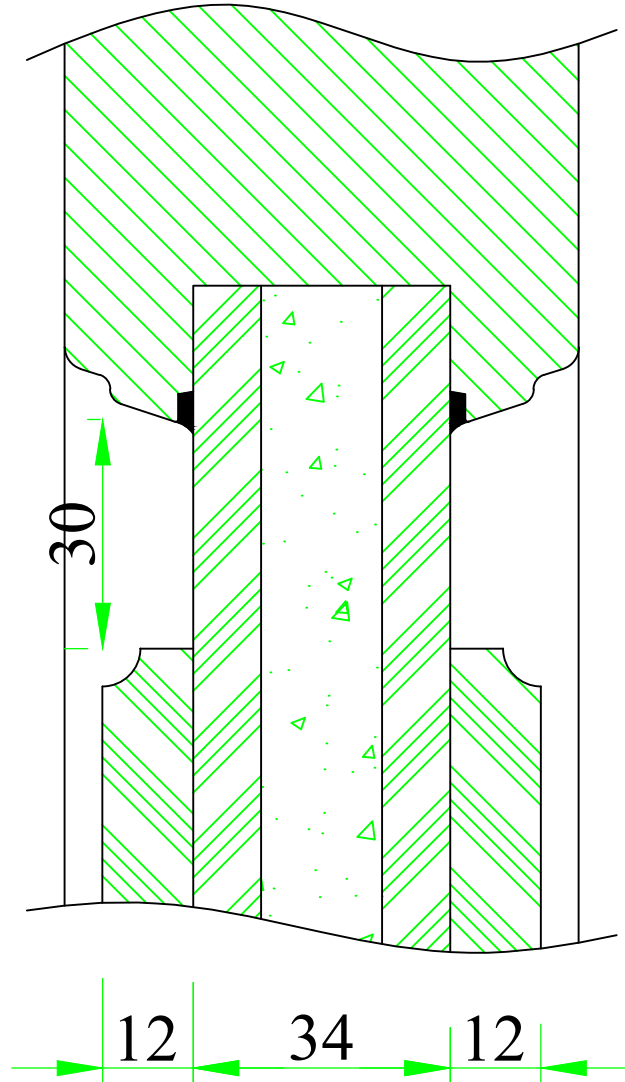
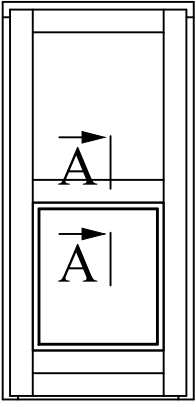

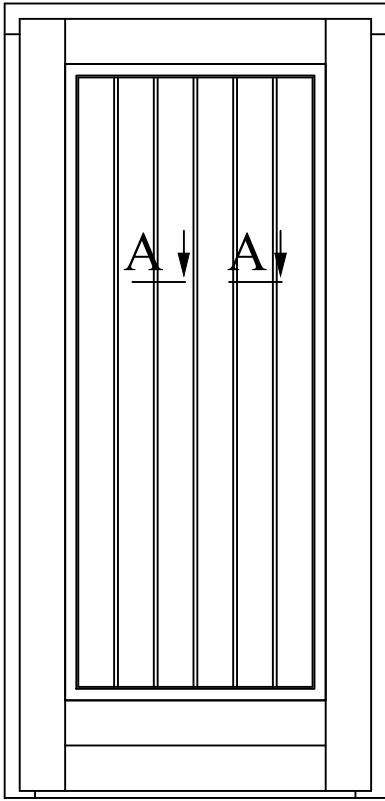

option A

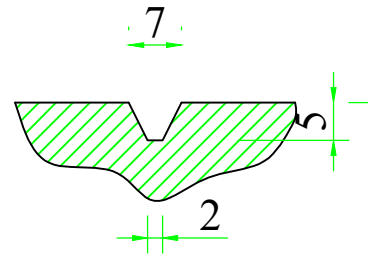

option B

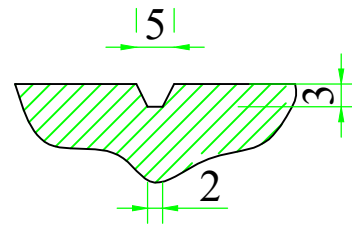

option C

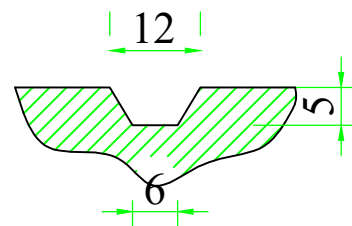

A

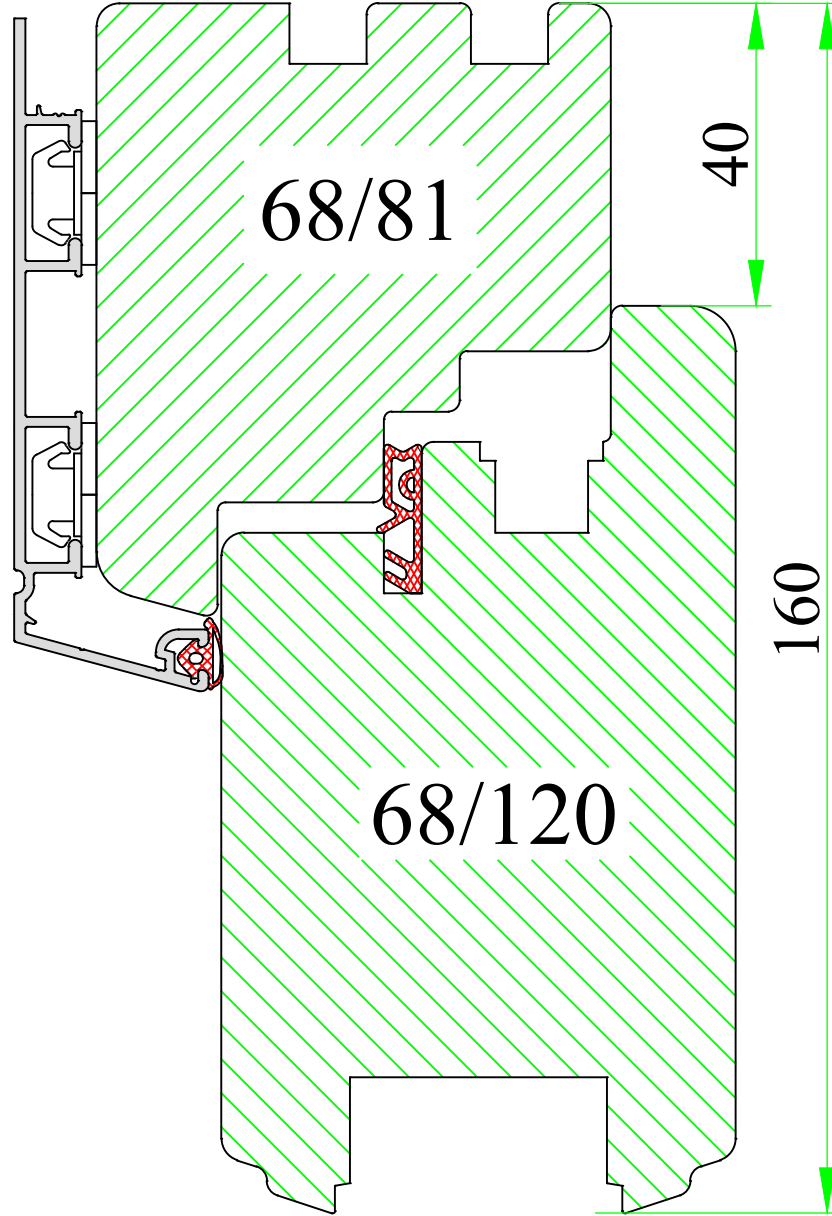
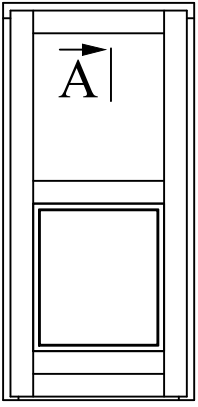

**UNI WINDOWS Ltd.**  
Unit 6, Edgefield Industrial Est.  
Loanhead, EH20 9TB  
Tel.: 0131 448 3931

HYBRID DZ

ENTRANCE DOOR 68

Version:  
1

Scale:  
1:1

Date:  
15.05.14

Drawing:  
NZ/39

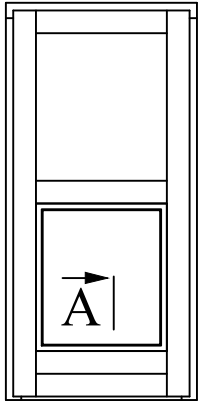

A

